



Yalıtım Sistemleri



Yenilikçiyiz
Creative



Çözüm Odaklıyız
Outcome-Oriented



Profosyoneliz
Professional



Yatırımcıyız
Investors



Memnuniyet Odaklıyız
Satisfaction-Oriented



Globaliz
Global

 www.isolion.com.tr



İÇİNDEKİLER - INDEX

Mantolama Panelleri / Fuga	4
Söveler / Window and Door Frame	6
Denizlikler / Window Sills.....	10
Kat Silmeleri / Floor Stringer	12
Taçlar / Crowns	15
Taç Motifleri / Decorative Crowns.....	18
Motifler / Decorates.....	20
Aplik ve Kilit Taşları / Keystone.....	21
Köşe Elemanları / Corners	22
Payandalar / Buttress.....	24
Harpuştalr / Cover Fence.....	25
Pvc Kapama / Pipe Covering Profiles	26
Sütun ve Başlıklar / Pilla	27
Mantolama / Coating.....	28
Stropiyer / Corinces.....	33
Tavan Kaplama / Ceiling Tile	38
Klasik Modeller / Classics	39
Lamba Göbekleri / Rosette	40



Sıcağı Karşı Korur
Protects Against Heat



Soğuca Karşı Korur
Protects Against Cold



Geri Dönüşümlü
Recyclable



Çevre Dostu
Environmentally Friendly



Kolay Montaj
Easy Application

iSO
Lion
Yalıtım Sistemleri

Yön Yapı Mühendislik A.Ş. taahhüt ve mühendislik hizmetleri verme amaçlı Gaziosmanpaşa'da kuruldu.

2005

Yön Yapı was established in Gaziosmanpaşa to provide engineering services.



Mantolama uygulama işlerine başladı.

2007

The company added contracting services "insulation and Coatings".



Tüm ısı yalıtım ürünlerinin toptan satışını yapmaya başladı.

2009

Our company started wholesale of all thermal insulation Products.



İSOLİON markası ile EPS üretim serüveni başladı.

2011

Our company started producing insulation products under ISOLION brand.



Yapı kimyasalları üretimi ile ısı yalıtım alanında hizmet ağını genişletti.

2012

Started producing construction chemicals and new insulation products.



Paydaşlarına daha iyi hizmet verebilmek için lokasyonunu Silivri'ye taşıdı.

2016

To start producing with bigger capacity and as a part of our expanding process we moved to Silivri.



Ürün portföyünü genişleterek 60'dan fazla ürün çeşidi ile 3 farklı kıtada 7 farklı ülkeyle ürünleri tanıştırdı.

2018

We started exporting to 7 countries in less than one year With more than 60 products.





KALİTE POLİTİKAMIZ

Firmamızın tüm kaynaklarını; Kalite Yönetim Sistemi ile bütünleşmiş sürekli gelişim temel felsefesini benimsemiş ve müşteri odaklı hizmet anlayışımız doğrultusunda kullanacağız.

Bunları yaparken; Çevreye ve insana saygı temel prensibiyle, yasal mevzuatlara bağlı olarak, iş güvenliği kurallarına uygun hareket etmek temel politikamızdır.

VİZYON

Paydaşlarımızın beklentilerini en üst düzeyde karşılayan, sevilen, güvenilen ve tercih edilen lider marka ve kurum olmak.

MİSYON

Paydaşlarımızdan aldığımız güç ile; sektörümüzde Türkiye de lider firmalar arasında yerini alarak toplumsal değer yaratmak.

OUR QUALITY POLICY

All resources of our company are allocated in accordance with our service policy which is CUSTOMER-ORIENT, adopts the basic philosophy of CONTINUOUS DEVELOPMENT, and integrated QUALITY MANAGEMENT SYSTEM.

While achieving these objectives; it is our policy to act according to WORK SAFETY rules adhering to the legal regulations with basic principle of RESPECT for the ENVIRONMENT and PEOPLE.

VISION

To become a leading brand and institution that meets expectations of its stakeholders at the highest level, that is loved, trusted and preferred.

MISSION

With the power we receive from our stakeholders; to create social value by becoming one of the leading companies in our sector.

P-101

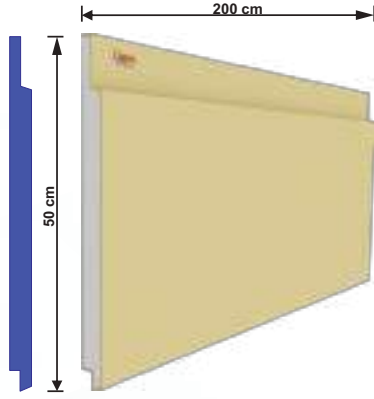

Kalınlık/Thickness: 3 - 4 - 5 cm

P-102

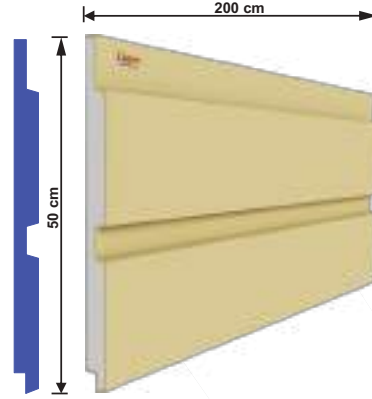

Kalınlık/Thickness: 3 - 4 - 5 cm

P-103

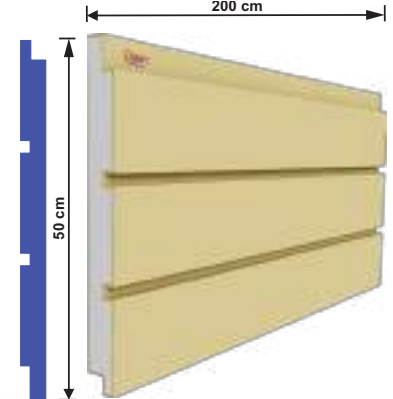

Kalınlık/Thickness: 3 - 4 - 5 cm

P-104

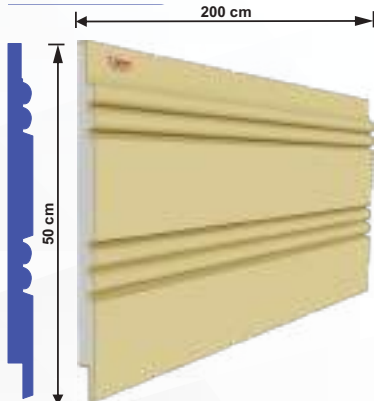

Kalınlık/Thickness: 3 - 4 - 5 cm

P-105

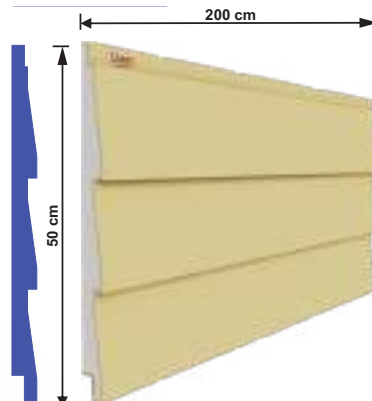

Kalınlık/Thickness: 3 - 4 - 5 cm

P-106

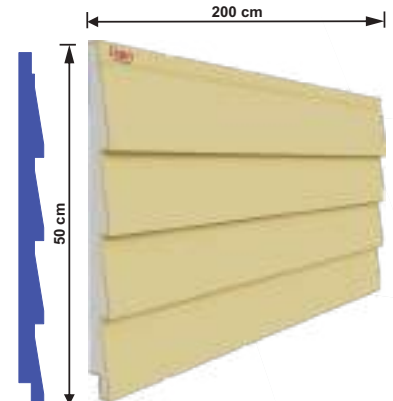

Kalınlık/Thickness: 3 - 4 - 5 cm

P-107

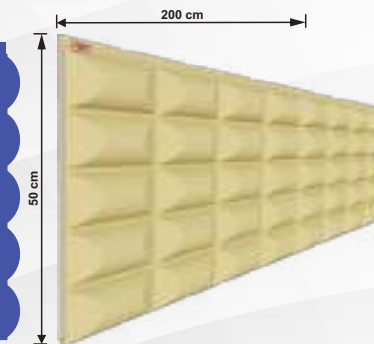

Kalınlık/Thickness: 3 - 4 - 5 cm

P-108

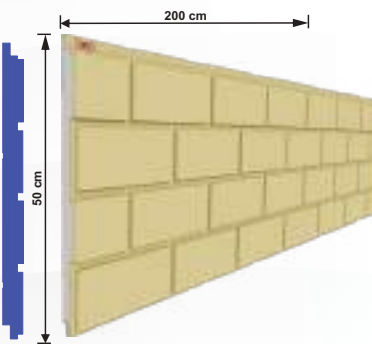

Kalınlık/Thickness: 3 - 4 - 5 cm

P-109

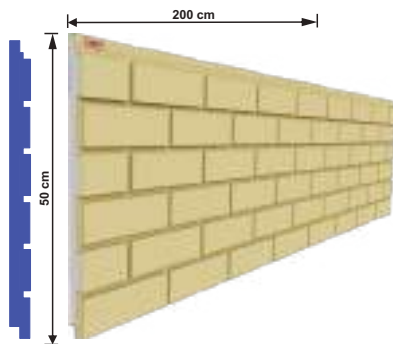

Kalınlık/Thickness: 3 - 4 - 5 cm

Mantolama Panelleri / Fuga

P-110

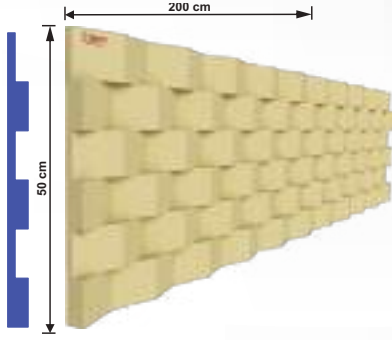

Kalınlık/Thickness: 3,5 - 4 - 5 cm

P-111

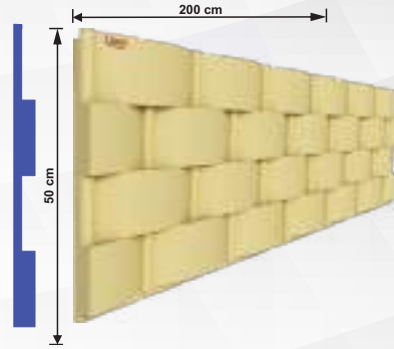

Kalınlık/Thickness: 3,5 - 4 - 5 cm

P-112

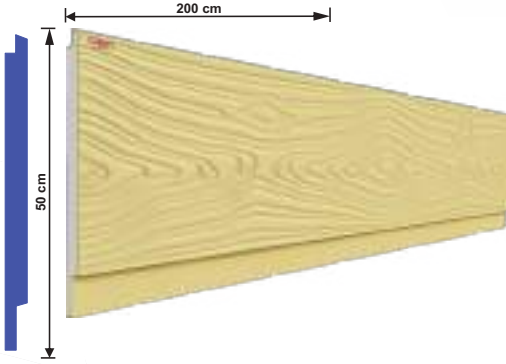

Kalınlık/Thickness: 3 - 4 - 5 cm

P-113

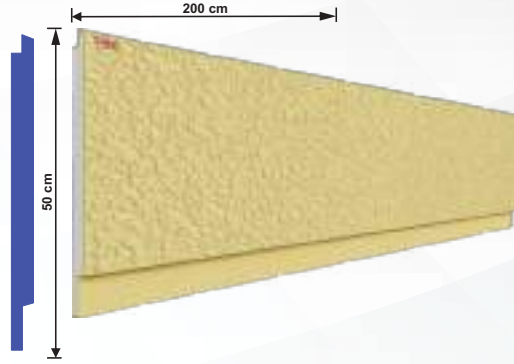

Kalınlık/Thickness: 3 - 4 - 5 cm



isolion En iyi dış cephe uygulamaları için
İZOLASYON LEVHA YAPIŞTIRMA HARCINI
ÖNERİYOR!

To get the best result for the external
interface: **WE ADVISE YOU TO USE isolion**
PLATE ADHESIVE MORTAR.

* Detaylı video, uygulama anlatımları için Qr Kodu Tarayınız!
* For more information, to see how to apply our products,
scan this QR code!



S-201



S-202



S-203



S-204



S-205



S-206



S-207



S-208



S-209



S-210



S-211



S-212



Söveler / Window and Door Frame

S-213



S-214



S-215



S-216



S-217



S-218



S-219



S-220



S-221



S-222



S-223



S-224



S-225



S-226



S-227



S-228



S-229



S-230



S-231



S-232



S-233



S-234



S-235



Söveler / Window and Door Frame

Söve Ürünleri Nasıl Uygulanır?

How to do Door & Window Frame Application?



- 1** Denizlikten başlayarak pencere ölçüleri alınır. Sonra gönye kesimleri yapılır.
The miter sections should be prepared by taking the measurements of the window firstly beginning from the windowsill.



- 2** İsolion 25 kg'lık levha yapıştırma harcı 6 lt su ile karıştırılarak homojen hale getirilir.
Isolion exterior adhesive should be mixed as 25 kg / 6 lt water until become homogen.



- 3** Malzemenin duvara monte edilecek kısmına ve birleşim yerlerine isolion levha yapıştırma harcı sürülmeli ve dışarı taşması sağlanmalıdır.
The adhesive is applied on surface facing the ceiling by spatula. Mortar should be applied on the joints and the adhesive should be effused from the joints.



- 4** Zemin montaj öncesi hazır hale getirilmelidir. Malzeme kaydırılarak yerine montajı sağlanmalıdır. Daha önceden terazisi alınmış ve işaretlenmiş yüzeye monte edilmelidir.
The surface is prepared for application. The material should be mounted by moving right and left. The material is applied on the pre-balanced and pre-marked surface.



- 5** Malzeme beton çivisi ile sabitlenmelidir.
The material should be fixed by a concrete nail, because the adhesive petrifies late.



- 6** Yanda kullanılan Söveler, sağa sola oynatılarak yerine montaj edilir. Birleşim noktalarında yapıştırıcı dışarı taşırılmalıdır. Malzeme montajından hemen sonra teraziye alınmalıdır.
Side frames should be mounted by moving right and left. The product should be balanced just after mounting.

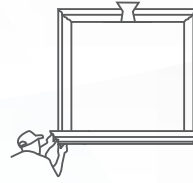

- 7** Taşan harçlar spatula yardımıyla temizlenmelidir. Yaklaşık 4-5 saat sonra zımpara ile rütüş yapılmalıdır.
The mortar should be cleaned by a spatula. It should be finished by an emery approximately after 4/5 hours.



D-301



D-302



D-303



D-304



D-305



D-306



D-307



D-308



D-309



D-310



D-311



D-312



Denizlikler / Window Sills

D-313



D-314



D-315



D-316



KS-401



KS-402



KS-403



KS-404



KS-405



KS-406



KS-407



KS-408



KS-409



KS-410

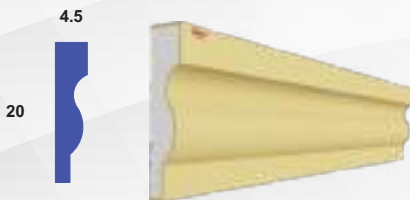

KS-411



KS-412



Kat Silmeleri / Floor Stringer

KS-413



KS-414



KS-415



KS-416



KS-417



KS-418



KS-419



KS-420



KS-421



KS-422



KS-423



KS-424



KS-425



KS-426



KS-427



KS-428



KS-429



KS-430



KS-431



KS-432



* Detaylı video, uygulama anlatımları için Qr Kodu Tarayınız!
* For more information, to see how to apply our products,
scan this QR code!



T-501



T-502



T-503



T-504



T-505



T-506



T-507



T-508



T-509



T-510



T-511



T-512



T-513



T-514



T-515



T-516



T-517



T-518



T-519



T-520



T-521



T-522



T-523



T-524



T-525



T-526



T-527

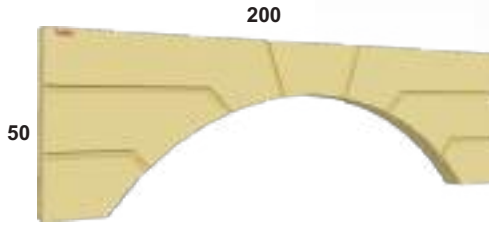

T-528

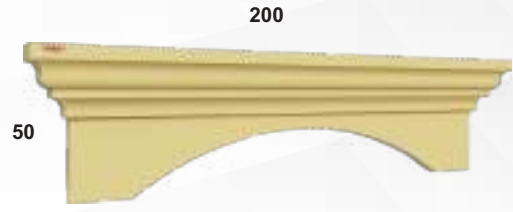

T-529



T-530



Istenilen Ölçüde Üretilir. / Can be produced according to the needed dimensions.

Istenilen Ölçüde Üretilir. / Can be produced according to the needed dimensions.



TM-601

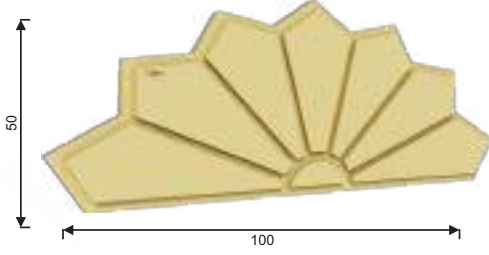

TM-602

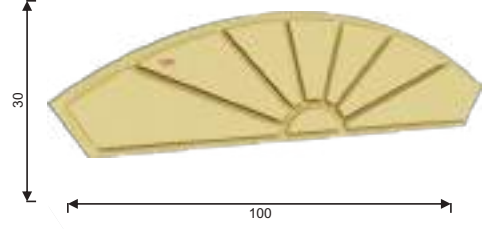

TM-603

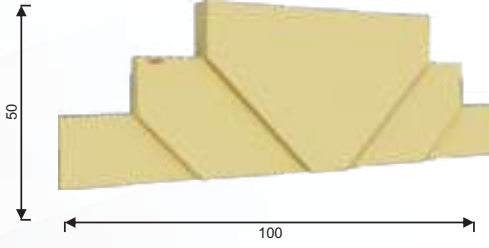

TM-604

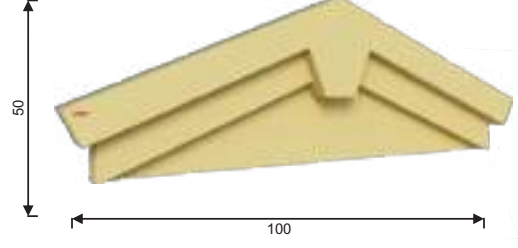

TM-605

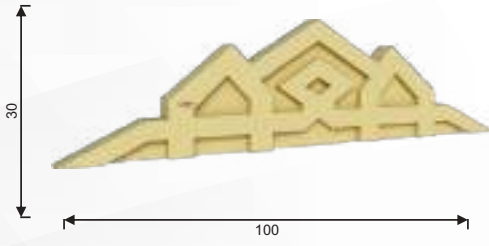

TM-606

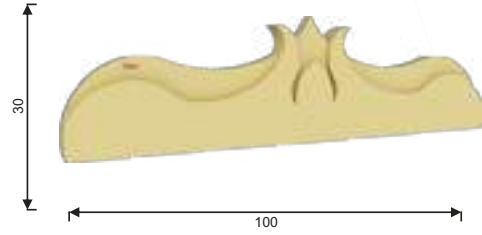

TM-607

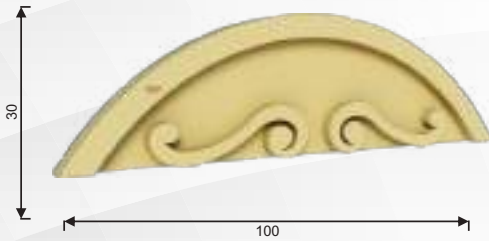

TM-608

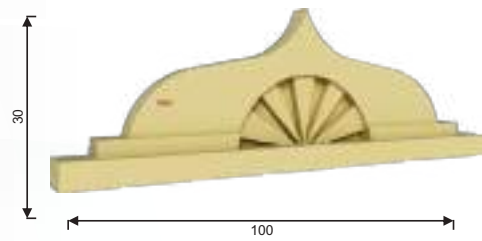

Taç Motifleri / Decorative Crowns

TM-609

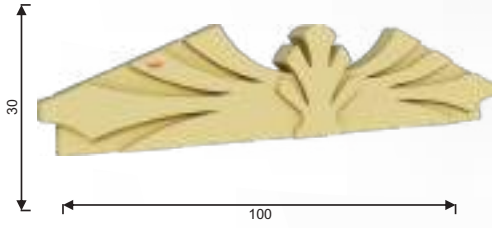

TM-610



TM-611

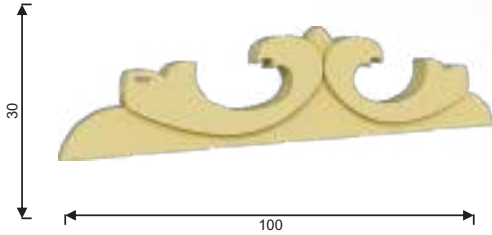

TM-612

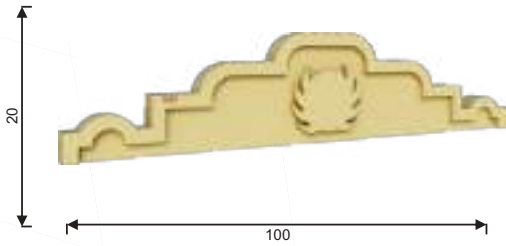

TM-613

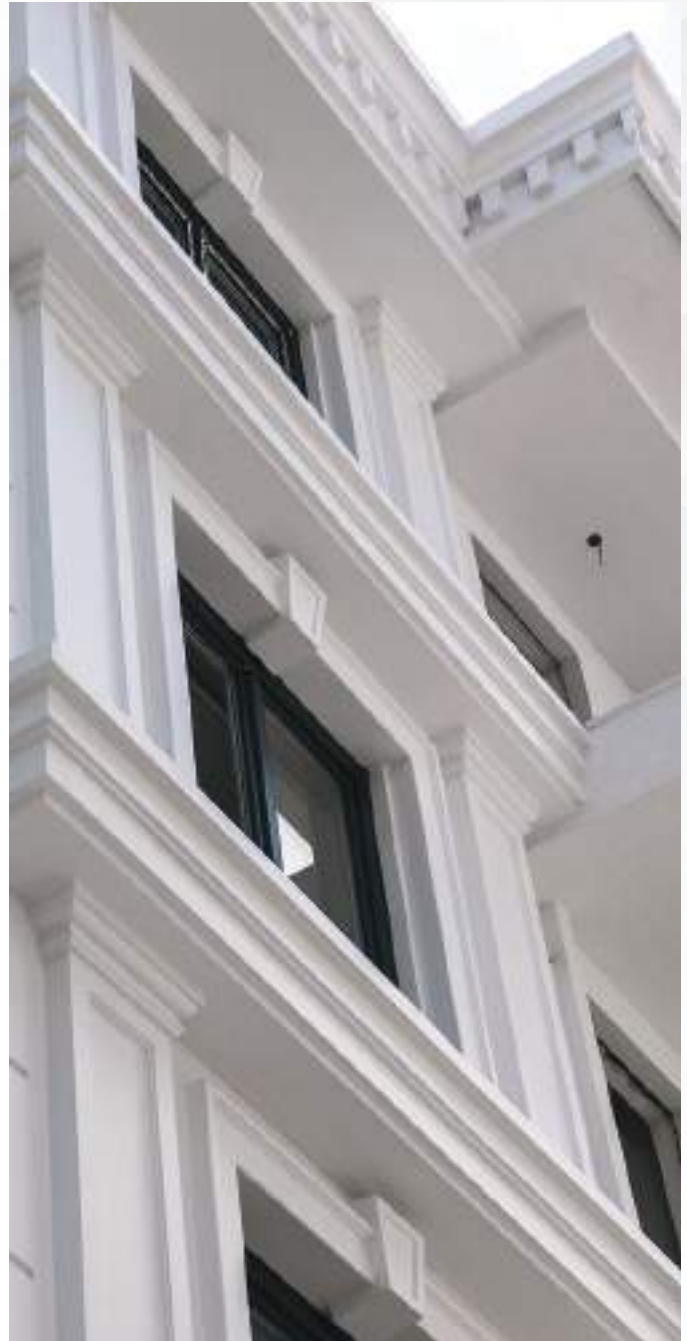
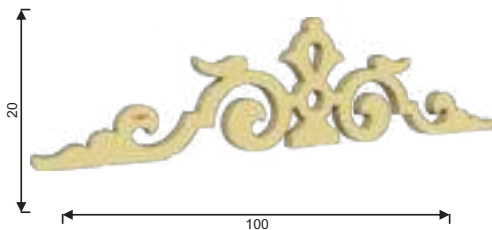

M-651

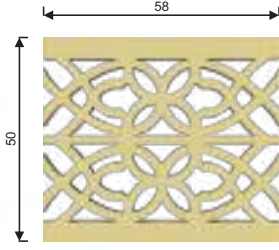

Kalınlık/Thickness: 3 - 4 - 5 cm

M-652

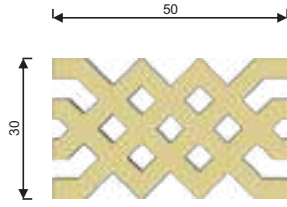

Kalınlık/Thickness: 3 - 4 - 5 cm

M-653

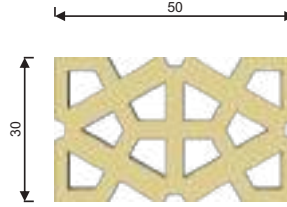

Kalınlık/Thickness: 3 - 4 - 5 cm

M-654

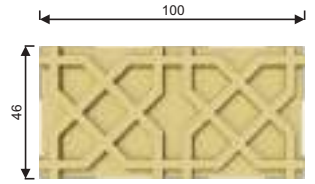

Kalınlık/Thickness: 5 cm

M-655

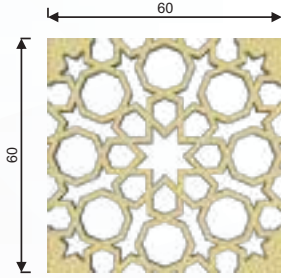

Kalınlık/Thickness: 3 - 4 - 5 cm

M-656

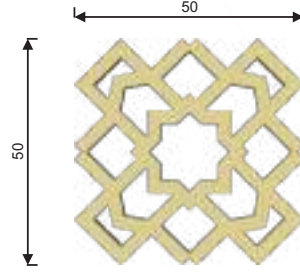

Kalınlık/Thickness: 3 - 4 - 5 cm

M-657

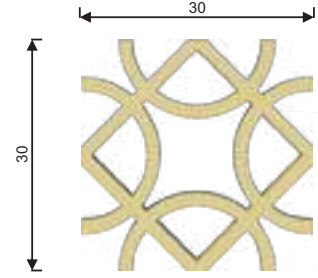

Kalınlık/Thickness: 3 - 4 - 5 cm

M-658

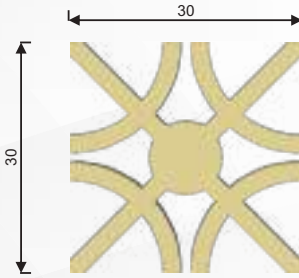

Kalınlık/Thickness: 3 - 4 - 5 cm

M-659

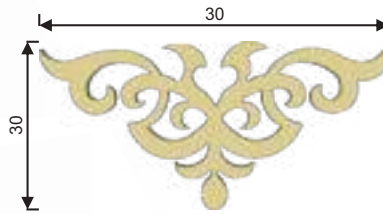

Kalınlık/Thickness: 3 - 4 - 5 cm

M-660

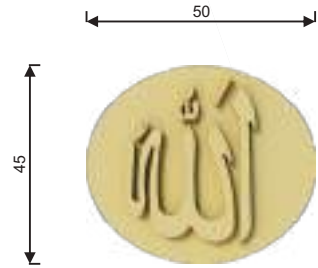

Kalınlık/Thickness: 3 - 4 - 5 cm

M-661

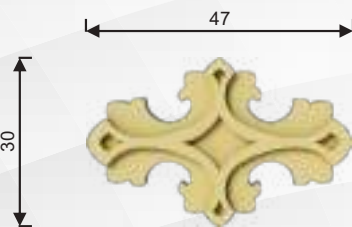

Kalınlık/Thickness: 3 - 4 - 5 cm

M-662

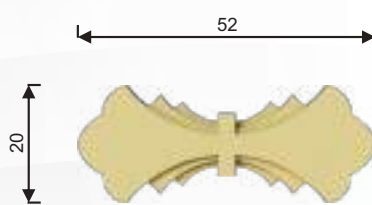

Kalınlık/Thickness: 3 - 4 - 5 cm

M-663

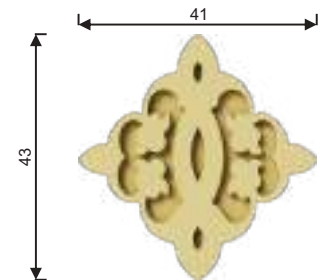

Kalınlık/Thickness: 3 - 4 - 5 cm

Aplik ve Kilit Taşları / Keystone

AP-701

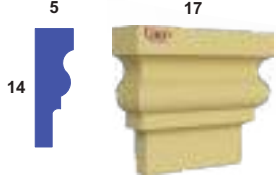

AP-702

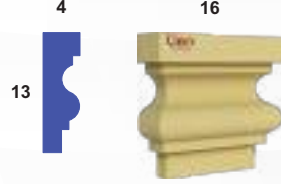

AP-703

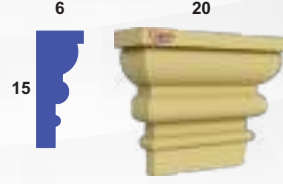

AP-704

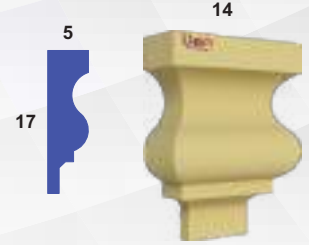

AP-705

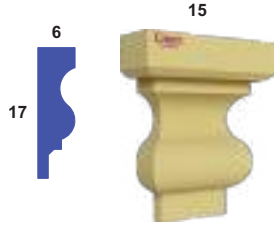

AP-706

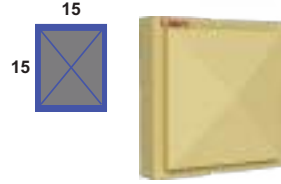

AP-707

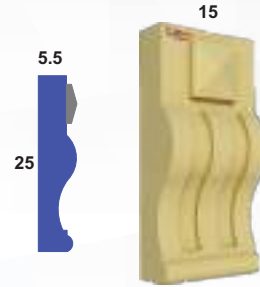

AP-708

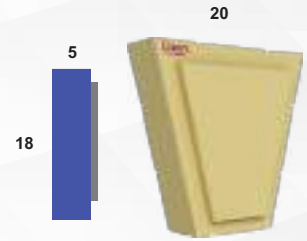

AP-709

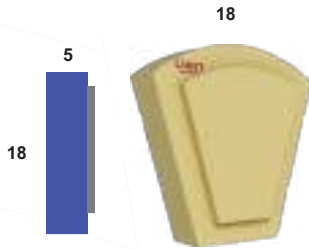

AP-710

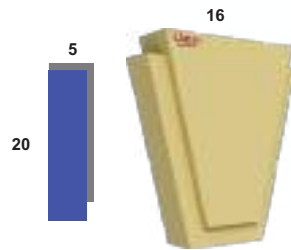

AP-711

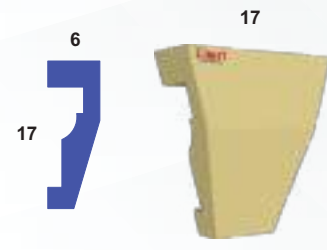

KE-801



KE-802



KE-803



KE-804



KE-805



KE-806



KE-807

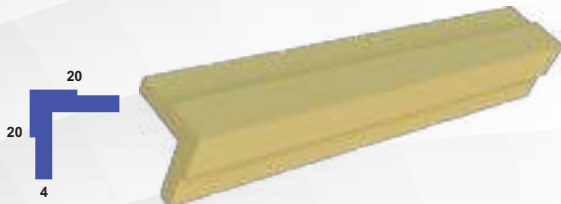

KE-808



Köşe Elemanları / Corners

KE-809



KE-810

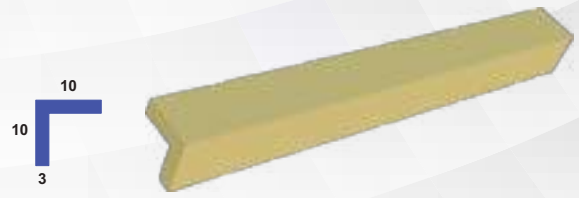

KE-811



KE-812

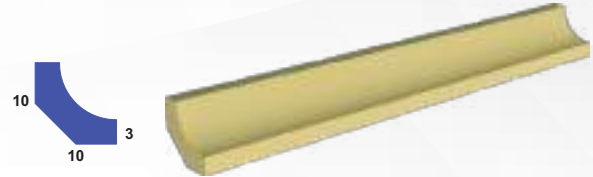

KE-813

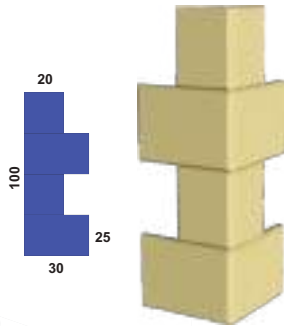

KE-814

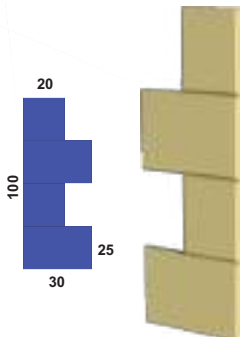

P-901

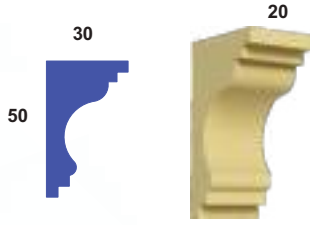

P-902

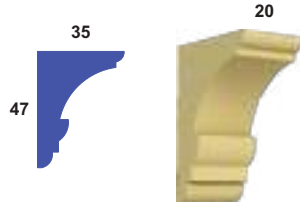

P-903

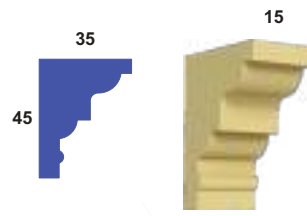

P-904

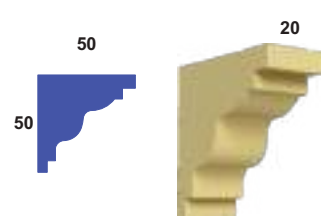

P-905

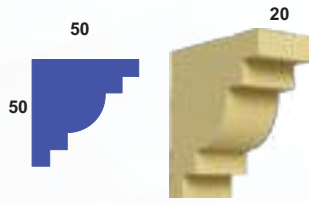

P-906

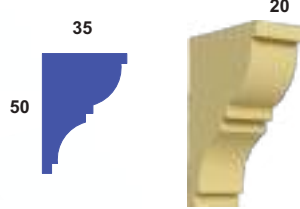

P-907

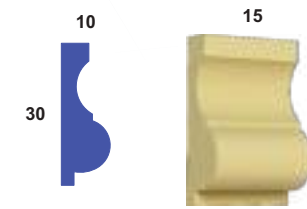

P-908

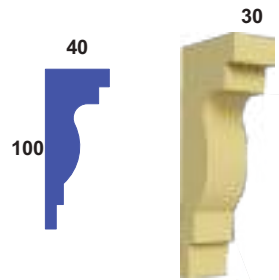

P-909

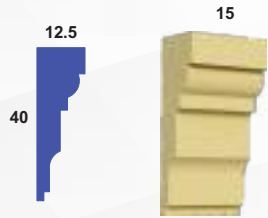

P-910

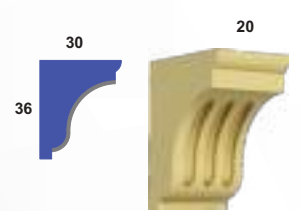

P-911

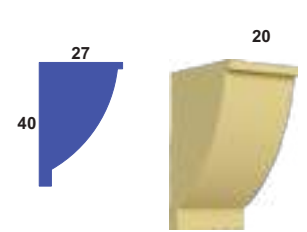

P-912

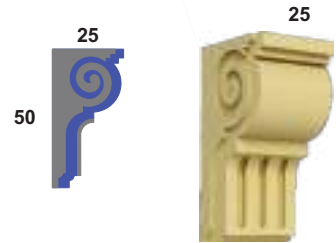

P-913

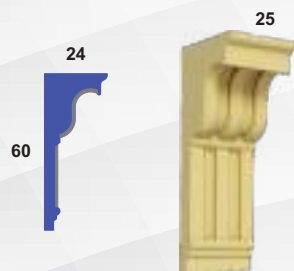

P-914

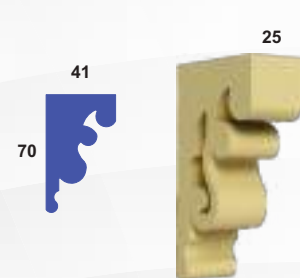

P-915

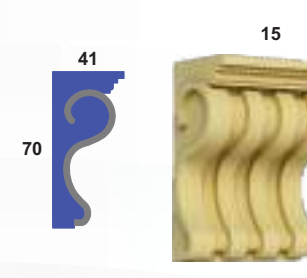

P-916

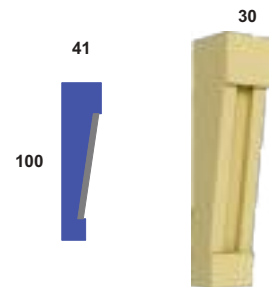

Harpuştalar / Cover Fence

H-1001

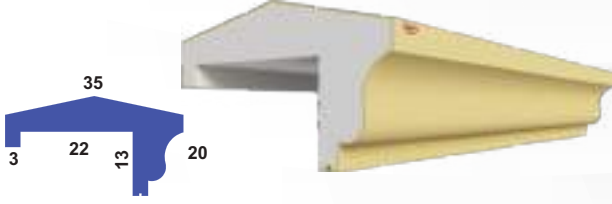

H-1002

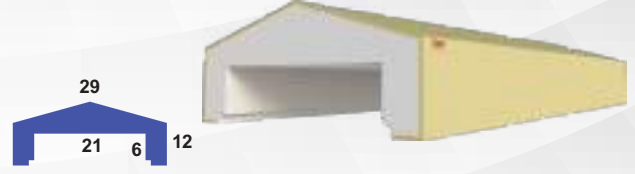

H-1003

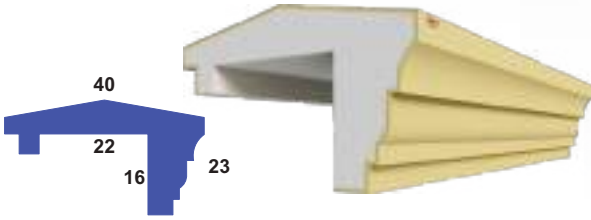

H-1004



PV-1051



70 - 100 -120'lik Pvc ile Uyumlu Üretilebilir.

PV-1052



70 - 100 -120'lik Pvc ile Uyumlu Üretilebilir.

PV-1053

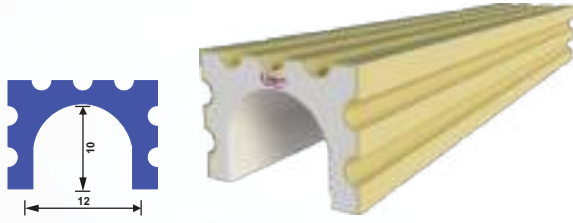

70 - 100 -120'lik Pvc ile Uyumlu Üretilebilir.

PV-1054



70 - 100 -120'lik Pvc ile Uyumlu Üretilebilir.

PV-1055

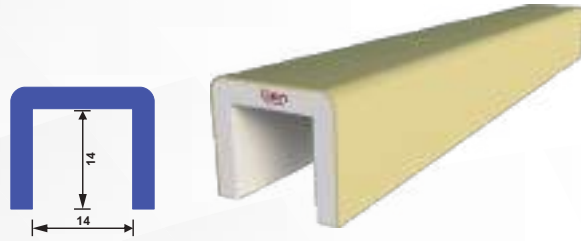

70 - 100 -120'lik Pvc ile Uyumlu Üretilebilir.

PV-1056



70 - 100 -120'lik Pvc ile Uyumlu Üretilebilir.

PV-1057



70 - 100 -120'lik Pvc ile Uyumlu Üretilebilir.



* Yeni ürünlerimizi görmek için Qr Kodu Tarayınız!
* To see our new products scan this QR code!

Sütun ve Başlıklar / Pilla

SB-1101

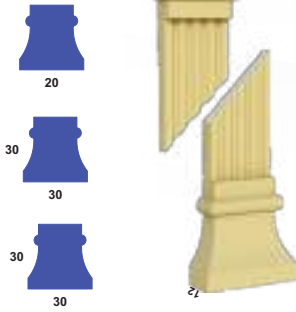

SB-1102

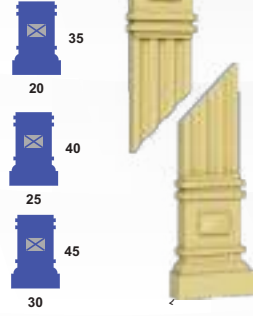

SB-1103

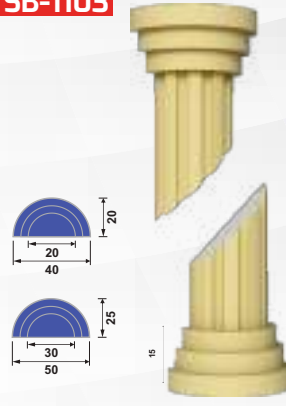

SB-1104

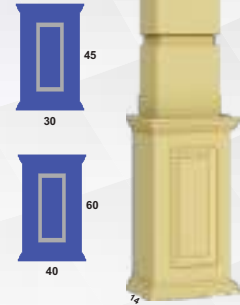

SB-1101

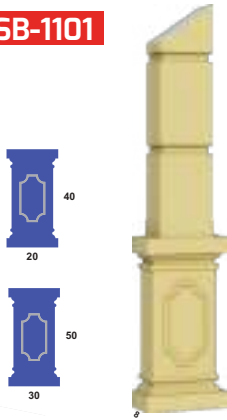

SB-1101

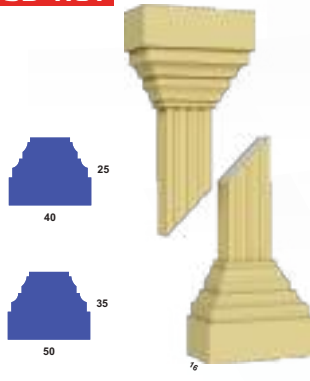

SB-1101

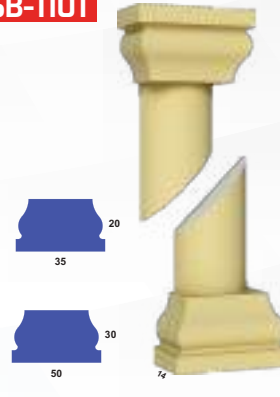

ST-1201

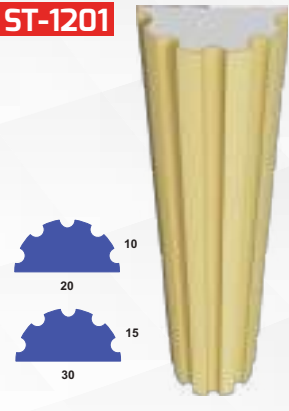

ST-1202

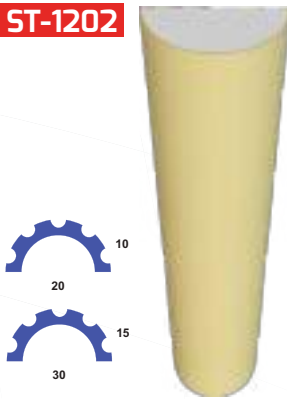

ST-1203

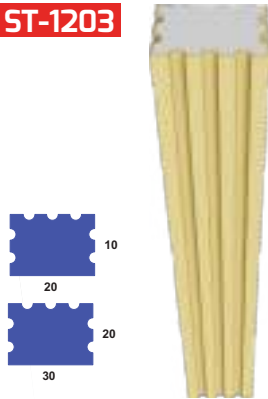

ST-1204

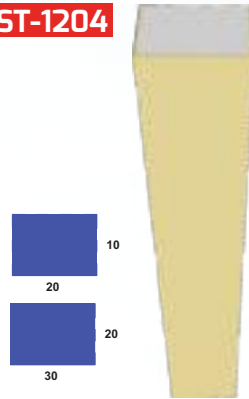

ST-1205

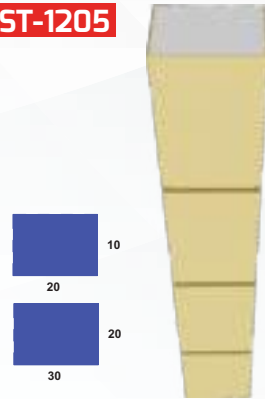

ST-1206

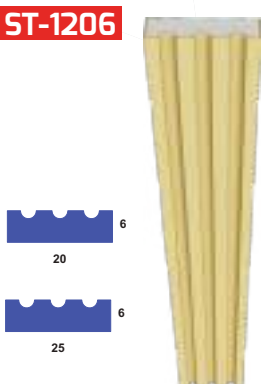

ST-1207

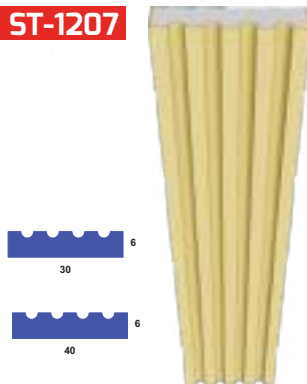

ST-1208

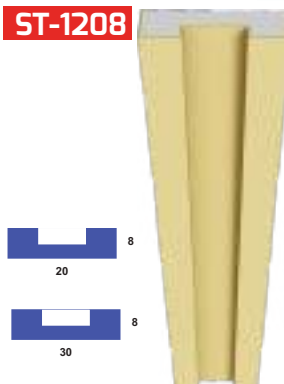

ST-1209

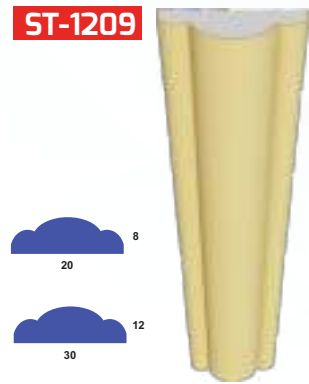



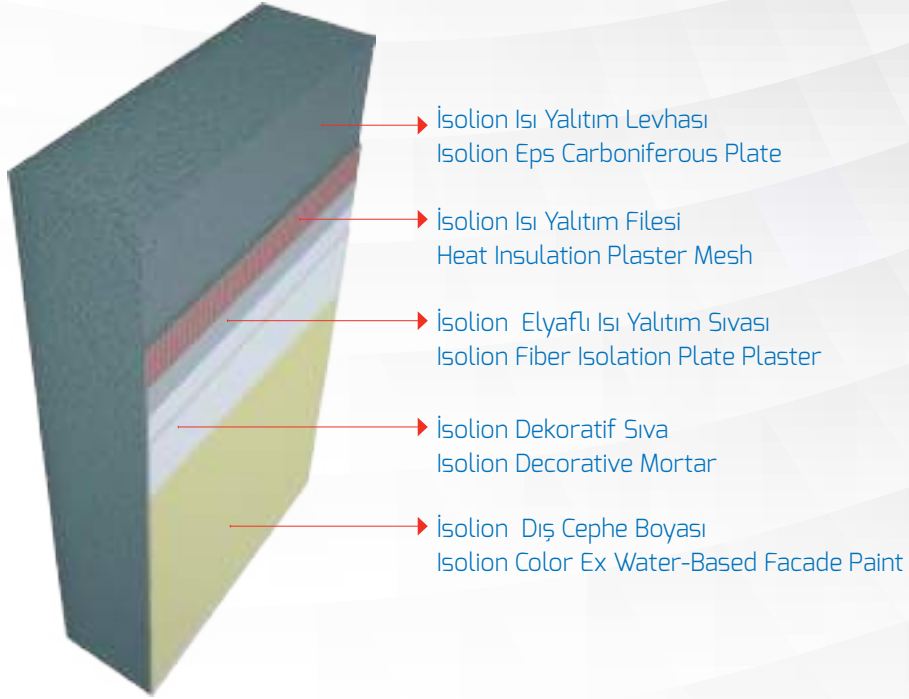

İSOLİON ISI YALITIMININ FAYDALARI

Yönetmeliklere uygun yapılacak ısı yalıtımı, ısınma veya serinleme amacıyla yaptığımız harcamalardan ortalama % 50 tasarruf ederek yazın serin kalmaya kışın daha iyi ısınmaya imkan sağlar.

Dengeli oda sıcaklıkları yaratarak konforlu ve sağlıklı mekanlar oluşturur.

Evlerde küflenme, siyah leke ve mantar oluşmasına neden olan yoğuşmayı (terlemeyi) önler. Isı yalıtımıyla ayrıca yakıt tüketimi ve dolayısıyla atık gazlar azaltılarak çevrenin korunmasına katkıda bulunulur.

ISOLION HEAT INSULATION BENEFITS

Heat insulation to be applied in accordance with regulations allow to stay cool during summer and better heating during winter by saving 50% from average costs in heating and cooling.

By creating stable room temperatures, it offers comfortable and healthy places.

It prevents condensation (sweat) that leads to mold, black stain and fungus in houses.

Beside, by means of thermal insulation, fuel consumption, thus, waste gases are reduced contributing to environmental protection.

* Detaylı video, uygulama anlatımları için Qr Kodu Tarayınız!
* For more information, to see how to apply our products,
scan this QR code!







İÇ CEPHE ÜRÜNLERİ
INTERIOR PRODUCTS



Stropiyer Nasıl Uygulanır?

How to do Covings Application?



- 1** Kullanım talimatına göre hazırlanmış olan yapıştırıcı spatula yardımıyla yeterli miktarlarda alınır.
Interior Adhesive, which is ready to use is taken by a spatula in certain amount.



- 2** Uygulama yüzeyi hazır hale getirilir. stropiyer modelinin basar ölçüsüne göre işaretlenip, ip yardımıyla montaj hattı belirlenir.
The surface is prepared for application. The measurements are taken and marked according to the tread of selected molding model. Montage line is determined by using a fiber.



- 3** Kesim aparatı ile iç ve dış gönyeleri alınır.
Inner and outer meters are prepared by using a cutting apparatus.



- 4** Yapıştırma harcı malzemelerin birleşir yerlerine gelen kısımlarına taşacak şekilde sürülür.
Adhesive must be applied at the joints of the two materials and adhesive should be effused.



- 5** İşaretlenmiş yerler üzerinden malzeme hizalı bir şekilde yapıştırılır. Birleşim yerlerini aynı hizaya getirmeye ve figürleri birbirine uyumlu hale getirmeye dikkat edilmelidir.
Material is bonded through the marked line. It is pad attention for aligning the joints of materials and interlock the figures.

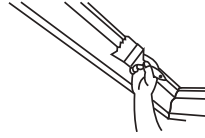

- 6** Sulu fırça ile ek yerleri ve temas bölgelerindeki pürüzler giderilir. İlk temizlik aşamasından 2-3 saat sonra tekrar rütuşlanmalıdır.
The burrs on the joints and contacts are corrected by a wet brush. The joints and corners should be retouched after 2 or 3 hours from the first cleaning.



Stropiyer / Corinces

SP-01



SP-02



SP-03



SP-04



SP-05



SP-06



SP-07

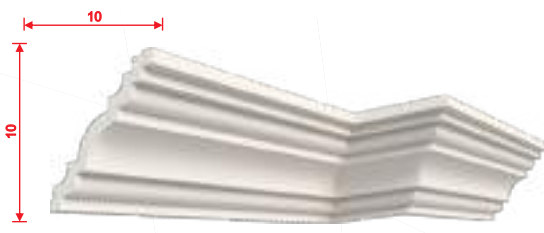

SP-08



SP-09



SP-10



SP-11



SP-12



SP-13



SP-14



SP-15



SP-16



SP-17



SP-18



SP-19



SP-20



Stropiyer / Corinces

SP-21



SP-22



SP-23



SP-24



SP-25



SP-26



SP-27



SP-28



SP-29



SP-30



SP-31



Ç-01



PER-12



PER-10



PER-08



* Yeni ürünlerimizi görmek için Qr Kodu Tarayınız!
* To see our new products scan this QR code!



Tavan Kaplama Nasıl Uygulanır?

How to do Ceiling Tiles Application?

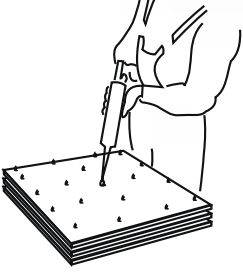

- 1** Özel yapıştırıcı malzeme üzerine küçük top taneler olarak uygulanır.
Interior Adhesive is applied on the material as small balls.

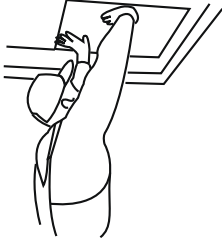

- 2** Yapıştırıcı dışarı taşırılmadan, kapı girişinin karşısında ki köşeden (ek parçaların göze batmaması için) başlanır. Yapıştırma sırasında malzemeye fazla baskı yapmadan "sağa ve sola oynatılarak" zemine yapıştırılmalıdır.
The adhesive is not effused and application begins from the corner at the opposite of entrance (for preventing the parts do not offend the eyes). The material should not be applied overpressure during bonding and it should be ensured that the adhesive is scattered on the surface by moving the plate right and left.

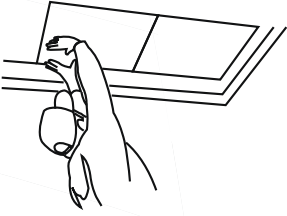

- 3** Uygulamaya tek bir köşeden başlayıp, sistematik bir şekilde devam ettirilmelidir.
The application should begin from a corner and continued systematically.

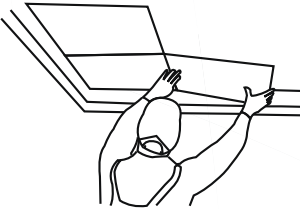

- 4** İki malzeme arasına dolgu yapılmamalı, dışarı taşan yapıştırıcılar derz olarak kullanılmamalıdır.
No filling should be applied between two materials and effused adhesive should not be used as suture.

TK-01



50x50 cm

TK-02



50x50 cm

TK-03

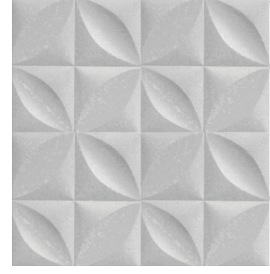

50x50 cm

TK-04



50x50 cm

TK-05



50x50 cm

ÇK-01



50x50 cm



Klasik Modeller / Classics

KLAS-1



KLAS-2



KLAS-3



KLAS-4



KLAS-5



* Yeni ürünlerimizi görmek için Qr Kodu Tarayınız!
* To see our new products scan this QR code!

En iyi tavan kaplama için ÖZEL TAVAN
KAPLAMA YAPIŞTIRICISINI ÖNERİYORUZ!
To get the best result for ceiling tile; WE
ADVISE YOU TO USE SPECIAL CEILING TILE'S
ADHESIVE.

GB - 01



GB - 02



GB - 03



GB - 04



GB - 05



GB - 06



Lamba Göbeği Uygulaması

Application of Rosette

- 1** Kullanım talimatına göre hazırlanmış olan özel yapıştırıcı spatula yardımıyla yeterli miktarlarda alınır.
Interior Adhesive, which is ready to use is taken by a Spatula in certain amount.



- 2** Özel yapıştırıcı, spatula yardımı ile sürülür.
Interior Adhesive is applied on the sides by a spatula

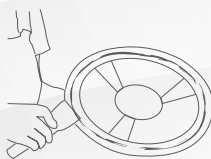

- 3** Göbek ortalanır, hafifçe bastırılır ve sağa sola oynatılarak yapıştırıcının kenardan taşması sağlanır.
Rosette is applied by centering, gently pushing and moving rightwards and leftwards. It's ensured that the adhesive is effused from the sides.

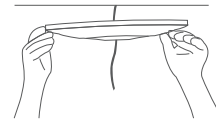

- 4** Dışarı taşan yapıştırıcıların, tavanla göbek arasında eşit şekilde dolgu yapılması sağlanır.
It's ensured that the effused adhesive is filled in the section between the rosette and ceiling equally.

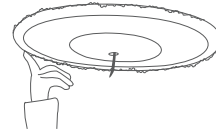

- 5** Malzemenin etrafına taşan yapıştırıcılar ıslak fırça yardımıyla temizlenir.
The adhesive effused around the material is cleaned by using a wet brush.

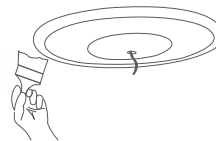

"Ustanın tercihi" Master's Choice



ISO
Lion
Yalıtım Sistemleri

TSE | **CE** | **ISO 9001:2015** | **ISO 14001:2015** | **OHSAS 18001:2007**



Dış Cephe Yeni Ürünler
Exterior New Products



İç Cephe Yeni Ürünler
Interior New Products



Söve Uygulaması
Apply of Exterior Decor



Mantolama Uygulaması
Apply of Coating



 **YÖN YAPI MÜHENDİSLİK A.Ş.**

Fener Mh. Fener Kaynak Sk. No: 7 Fenerköy - Silivri - İSTANBUL - TURKEY

Tel: 0212 597 88 80 Faks: 0212 597 88 40

 export@yonyapi.com.tr  +90 530 016 90 74